

LEGACY WALL MOUNT

SPECIFICATIONS

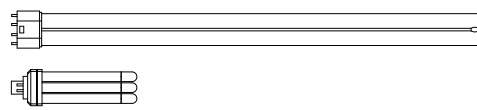

Trim: Trim ring is 20-gauge spun steel and attaches to luminous bowl with no visible hardware. Medallions are cast aluminum.

Luminous Bowl: Bowl is formed white opal acrylic standard with the option of three faux alabaster choices. Lamp housing has no open holes to minimize the collection of dust and debris in bowl. Dust cover is optional.

Reflector: Biaxial fluorescent reflector is a combination of high reflectance specular aluminum and high reflectance white powder coat paint. CFL reflector is high reflectance white powder coat paint.

Suspension: Wall mount hook (WMH) or wall mount arm (WMA).

Electrical: Fluorescent ballasts are instant start, normal light output, high power factor, and sound rated A. Ballast factor varies between 0.86 and 0.90 depending on lamp wattage, number of lamps, and voltage. Consult factory for specific ballast factor.

Finish: Standard colors are available from color chart. Plated finishes and custom colors are available.

Certification: UL and CUL listed and IBEW labeled.

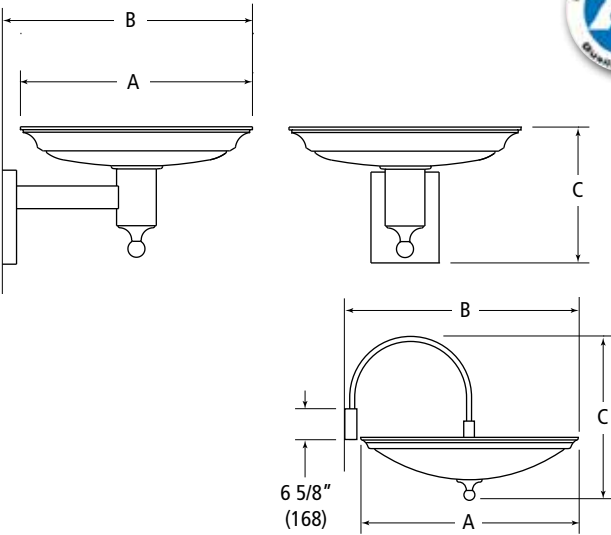

WMA DIMENSIONAL DATA TABLE

| Diameter | A | B | C |
|----------|----------------|-----------------|------------------|
| 20" | 20 3/4" 527 | 22 1/16" 560 | 12" 305 |
| 29" | 28 5/8" 727 | 30 1/4" 768 | 13 15/16" 354 |

WMH DIMENSIONAL DATA TABLE

| Diameter | A | B | C |
|----------|----------------|-----------------|----------------|
| 20" | 20 3/4" 527 | 22 1/16" 560 | 26 1/4" 667 |
| 29" | 28 5/8" 727 | 30 1/4" 768 | 29 3/4" 756 |

EXAMPLE

| fixture series | lamps up | lamps down | trim ring style | finial | mounting | finish | voltage | options |
|----------------|---------------------------------|---------------|---|--|---|---|--------------------------|--|
| LDL29 | 3/39 | 1/282D | A | A | WMA | SGW | 120 | ALB/2 |
| LDL20 | 4/26CFL 2/27BX | N/A | A -Chippendale B -Barcelona E -Baltic G -Venetian H -Von Wagner I -Edinburgh | A -Chippendale B -Barcelona N -none | WMH -wall mount hook WMA -wall mount arm | SGW -semi-gloss white (refer to color chart in Product Selection Guide for other standard colors) SCH -satin chrome CH -polished chrome BR -polished brass AB -antique brass SBN -satin brushed nickel PN -polished nickel CC -custom color | 120 277 | GLR -GLR fuse and HLR holder GMF -GMF slow blow fuse and holder DC -Dust cover ALB/# -Faux alabaster bowl (see color chart for #) EM1 -B70A or equal EM2 -B50 or equal EM3 -B100 or equal EM4 -B60 or equal DIM1 -Advance Mark VII dimming DIM2 -Advance Mark X dimming DIM3 -Lutron ECO-10 dimming ballast DIM4 -Lutron Hi-Lume dimming ballast DIM5 -Lutron ECO-10 TVE dimming ballast (see opposite page for emergency and dimming limitations) |

Due to a program of continuous improvement, LAM Lighting reserves the right to make any variation in design or construction to the equipment described. Check www.LamLighting.com for the most current spec sheet.

ORDER

project name: _____ type: _____ quantity: _____

- - - - - - - -

LAMP CONFIGURATIONS

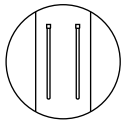

LDL20-2

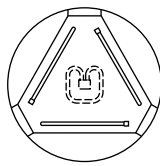

LDL29-3

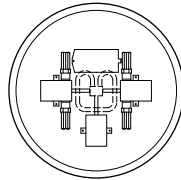

LDL-CFL

TRIM RING STYLES

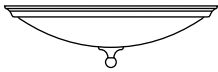

Chippendale

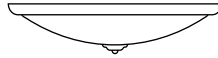

Barcelona

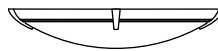

Edinburgh

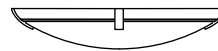

Baltic

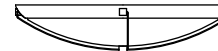

Venetian

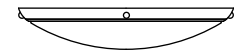

Von Wagner

EMERGENCY POWER

| Fixture Diameter | Uplight lamps | Battery Location | Limitations |
|------------------|---------------|------------------|--------------------------------|
| 20 | 4/26 | Remote | 3-feet maximum remote distance |
| 20 | 2/27 | Remote | 3-feet maximum remote distance |
| 29 | 4/26 | Integral | 1 circuit (1 ballast) uplight |
| 29 | 3/39 | Integral | 1 circuit (1 ballast) uplight |

DIMMING

| Fixture Diameter | Uplight lamps | DIM1 | DIM2 | DIM3 | DIM4 | DIM5 |
|------------------|---------------|------|------|------|------|------|
| 20 | 4/26 | Yes | Yes | No | Yes | No |
| 20 | 2/27 | No | No | No | No | No |
| 29 | 4/26 | Yes | Yes | No | Yes | No |
| 29 | 3/39 | Yes | Yes | Yes | Yes | No |